

5 Nm RC5 33 Watts 33 W Part number made to order



- Torque rating : 5 Nm, for long service life
- Motors : nominal power 27 W
- All-metal high-quality gearboxes, "integrated" geared motors
- Base speed range : 7.4 to 426 rpm
- UL approved

Part numbers

	Type	Type	Voltage	Standard speed (rpm)	Output speed (rpm)	Ratios (i)
80835018	33 W	808350	-	-	7,4	245

Specifications

General characteristics

Motor	828300
Gearbox	810350
Maximum permitted torque from gearmotor under continuous conditions (Nm)	5
Axial load dynamic (daN)	6
Radial load dynamic (daN)	6
Max. output power (W)	33
Nominal output (W)	27
Gearbox case temperature rise (°C)	50
Weight (g)	1540
Approvals	UL 1004

Made to order products, available on request

Motors :

- Other supply voltages
- Shaft lengths at front and/or rear
- Built-in interference suppression on 82 830
- Encoders
- Other fixing flanges on front and rear
- "High-power" motors

Gearboxes :

- Special shaft
- Special greasing
- Other reduction ratios

Dimensions (mm)

808350

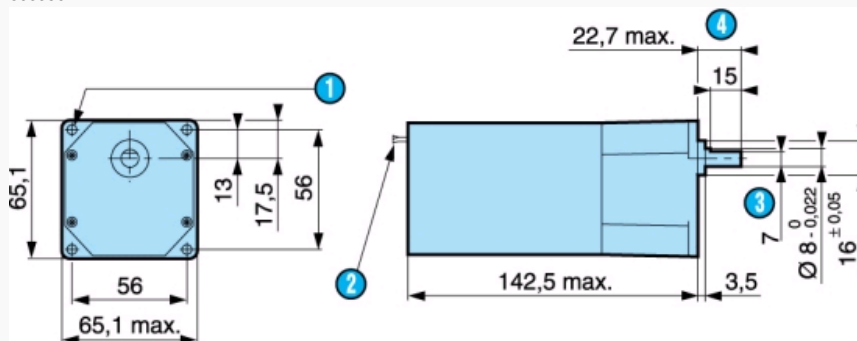

N°	Legend
1	4 fixing holes Ø 4.2
2	Lead length 200 mm ± 10
3	7 across flats
4	Shaft pushed-in

Dimensions (mm)

Gearbox shaft 79290064

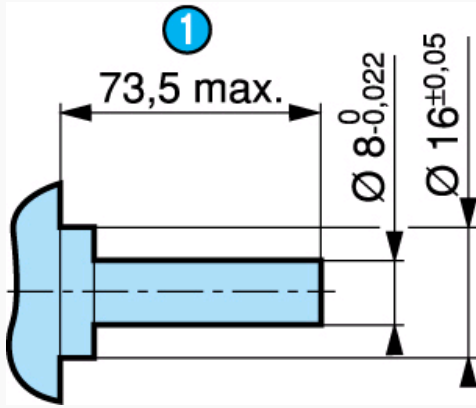

N°	Legend
1	Shaft pushed-in

Curves

Curve : torque/nominal speed

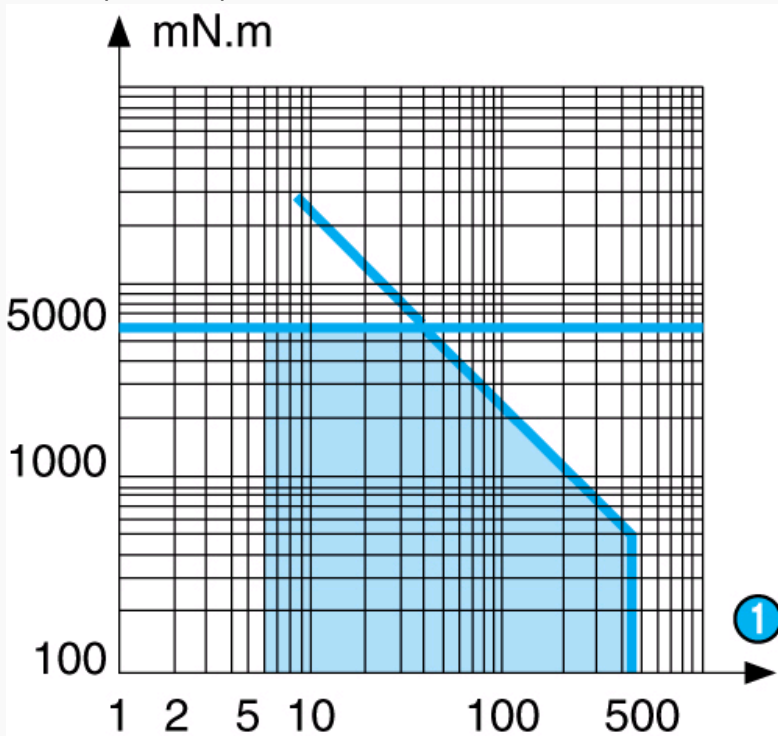

N°	Legend
1	rpm

Other information

Options

- Ball bearings on gearbox output shaft : part number becomes 808355
- EMC filter
- 48 V, 90 V, 110 V motor
- 1- or 2-channel encoder, 1, 5 or 12 pulses/revolution

Product adaptations



- Special supply voltage
- Special cable length
- Optical or Hall effect encoder
- Special connectors
- Special shaft
- Special reduction ratio
- Special materials for gears
- Special ball bearings
- Special adaptor plate
- UL/CSA logo on label
- With 828305 - 67 W motors